

Number Portability in Sweden – Network solutions for Service Provider Portability for public digital mobile telephony services

Nummerportabilitet i Sverige – Nätlösningar för digital mobiltelefonitjänst

A Swedish National Standard for handling number portability for public digital mobile telephony services between public telecommunications networks

Contents

Contents	1
Preface	2
Introduction	2
1 Scope	3
2 References	3
3 Terms and definitions	5
4 Abbreviations	9
5 Methods and Procedures of Mobile Number Portability	9
6 Traffic handling cases	13
7 Supplementary Services	15
8 Cancellation of subscriptions	16
9 The Network Interface	16
10 Information from the Administrative Interface	19
Annex A (informative) – Traffic handling cases	20

Preface

This standard is structured in the following way:

Introduction is a general introduction to the document.

Clause 1 describes the scope of the document.

Clause 2 lists reference documents.

Clause 3 lists terms and definitions used in the document.

Clause 4 explains abbreviations used in the document.

Clause 5 describes the methods and procedures used for realisation of mobile number portability.

Clause 6 describes the normal procedures and the abnormal cases used in connection with mobile number portability.

Clause 7 describes how the supplementary services are handled.

Clause 8 describes how cancellation of subscriptions is handled.

Clause 9 describes the network interfaces for call related and non-call related traffic.

Clause 10 describes the relation to the Administrative Interface.

Annex A provides examples of traffic handling cases to help the reader understand how to apply the rules and procedures.

The administrative interface and the reference database for the support of mobile number portability are described in the Swedish Standard: **SS 63 63 91:2000 Edition 2**, *Number portability in Sweden – Administrative process for number portability, including the administrative interface and the central reference database* [8].

This standard is produced by Working Group 15, AG15 of Information Technology Standardization, ITS. Members of the group have been interested parties representing the telecommunications operators and industry.

Introduction

This standard describes the requirements imposed on the public telecommunications network, the network interface and the information which has to be exchanged over the Administrative Interfaces between public telecommunications operators in Sweden, for the support of Service Provider Portability for public digital mobile telephony services.

The introduction of Service Provider Portability will change the present routing and charging principles. The identification of the public telecommunications network to which a Directory Number belongs, requires analysis of the complete number.

The considerations and assumptions made concerning the introduction of Service Provider Portability for public digital mobile telephony services in Sweden are accounted for in Report ITS 14, see reference [14].

1 Scope

This standard concerns network interconnection rules and procedures of Service Provider Portability for public digital mobile telephony services between public telecommunications operators in Sweden. In this standard, Mobile Number Portability is used in the sense of Service Provider Portability.

It describes the mobile number portability Network Interface defined between public telecommunications operators, and the different methods compatible with the mobile number portability Network Interface. Routing rules for the ISDN User Part (ISUP) for call related traffic, and routing rules and the necessary changes of the Signalling Connection Control Part (SCCP) parameters for non-call related traffic are also defined.

The administrative process and interfaces between databases (administrative and reference) are outside the scope of this standard, but necessary information identified for the technical solutions is listed. Numbers which are portable in the sense of this standard are subscriber numbers for the public digital mobile telephony service in the public telecommunications network according to regulations issued by the National Post & Telecom Agency. The International Mobile Subscriber Identity (IMSI) shall not be ported.

This standard does not settle the commercial commitments between public telecommunications operators.

2 References

2.1 Normative References

- | | |
|---------------------------|--|
| ETSI EN 301 715 V7.0.2 | Digital cellular telecommunications system (Phase2+), Support of Mobile Number Portability (MNP), Service description, Stage 1, (GSM 02.66 version 7.0.2 Release 1998) (1999-12) [1] |
| ETSI EN 301 716 V7.1.0 | Digital cellular telecommunications system (Phase2+), Support of Mobile Number Portability (MNP), Technical Realization, Stage 2 (GSM 03.66 Version 7.1.0 Release 1998) [2] |
| ITU-T Rec. Q.769.1 | Signalling System No. 7 – ISDN user part enhancements for the support of number portability (ITU-T ISUP 2000) [3] |
| ITU-T Rec. Q.850 | Usage of Cause and Location in the Digital Subscriber Signalling System No. 1 and the Signalling System No. 7 ISDN User Part (03/93) [4] |
| ITU-T Rec. I.210 | Principles of telecommunication services supported by an ISDN and the means to describe them (03/93) [5] |
| ITU-T Rec. Q.711 – Q.715 | Specifications of Signalling System No.7 – Signalling Connection Control Part (SCCP) (07/96) [6] |
| SS 63 63 90, ed. 1 (1999) | Number Portability in Sweden – Network solution for Service provider Portability for fixed public telecommunications services [7] |
| SS 63 63 91, ed. 2 (2000) | Number Portability in Sweden – Administrative process for number portability, including the administrative interface and the central reference database [8] |

SS 63 63 93, ed. 1 (2000)	PSTN-ISDN-PLMN ISUP signalling interface for Sweden [9]
SS-ISO 8601 (1991)	Data elements and interchange formats – Information interchange – Representation of date and time [10]
Report ITS 9 Edition 2	Application guide – Transfer of number information in national interconnection [11]
Svensk nummerplan för telefoni (E.164)	NPTA decision Hk 94-4621 and additional decisions, see PTS web page http://www.pts.se . [12]
ETSI TR 101 122	Network Aspects (NA) – Numbering and addressing for number portability, V1.1.1 (1997-11) [13]

2.2 Informative References

Report ITS 14	Number Portability in Sweden – Network solution for Service Provider Portability for public digital mobile telephony services – Technical prestudy [14]
ETSI EN 300 356-1	Integrated Services Digital Network (ISDN) – Signalling System No.7 – ISDN User Part (ISUP) version 3 for the international interface – Part 1: Basic services – [ITU-T Recommendations Q.761 to Q.764 (1997), modified] [15]
ETSI TR 101 118	Network Aspects (NA) – High level network architectures and solutions to support number portability. V1.1.1 (1997-11) [16]
ETSI TR 101 119	Network Aspects (NA) – High level description of number portability. V1.1.1 (1997-11) [17]
ETSI TR 101 621 V1.1.1	Network Aspects, Number portability task force, Consequences of mobile number portability on the PSTN/ISDN and synergy between geographic and mobile number portability [18]
ITU-T Rec. Q.761 – 764	Integrated Services Digital Network User Part (ISUP), ISUP 2000 [19]
OVUM - Number Portability in Sweden	Ovum's study (report and annexes) on the possible introduction of Number Portability (February 1997) [20]
PTSFS 1999:3	Post- och telestyrelsens föreskrifter och allmänna råd om nummerportabilitet för fasta teletjänster [21]
PTSFS 1999:4	Föreskrifter om ändring i Post- och telestyrelsens föreskrifter (1994:15) om tilldelning och reservering av nummerkapacitet ur den svenska nummerplanen för telefoni (E.164) [22]
Regeringens proposition 1997/1998:126	Nummerfrågor [23]
ITU-T Rec. E.164	The international public telecommunication numbering plan. (05/97) [24]

3 Terms and definitions

For the purpose of this standard, the following terms and definitions apply. Some of the terms and definitions in this standard differ from those in the ETSI MNP standard [2]. The differences are indicated in Report ITS 14 [14].

3.1 Entities

3.1.1 network operator

An entity operating a public telecommunications network in order to route calls.

NOTE: A Network Operator can also be the service provider.

3.1.2 numbering plan administration (NPA)

An entity responsible for the administration and assignment of numbers, or number blocks, within a national numbering plan.

NOTE: In Sweden it is the National Post & Telecom Agency.

3.1.3 number range holder

An entity responsible for the administration and allocation of numbers within a particular range.

3.1.4 public telecommunications operator (PTO)

A telecommunications operator in Sweden offering public telecommunications services.

NOTE: This term includes both Service Provider and Network Operator.

3.1.5 service provider

An entity offering public telecommunications services to subscribers and users involving the use of network resources.

NOTE: Service Provider is, in this standard, used in a generic sense, and may have a different status according to the service provided.

3.2 Numbers

3.2.1 directory number (DN)

An E.164 number in the national numbering plan assigned to a subscriber for a public telecommunications service.

NOTE: The Directory Number is assigned directly to subscribers by the public telecommunications operators from number ranges assigned by the NPA. The use of the Directory Number in this standard could be in either the national format (national (trunk) prefix + NDC + SN) or the international format (CC + NDC + SN). The latter is equal to MSISDN.

3.2.2 international mobile subscriber identity (IMSI)

The IMSI is a string of decimal digits, up to a maximum of 15 digits, that identifies a unique mobile terminal or mobile subscriber internationally.

3.2.3 national (significant) number

The portion of the number that follows the national (trunk) prefix. The national (significant) number consists of the National Destination Code (NDC) followed by the Subscriber Number (SN).

3.2.4 ported number

A Directory Number subject to mobile number portability.

3.2.5 redirecting number

Information sent in the forward direction when a call is diverted, indicating the number from which the call was diverted.

3.2.6 routing number

A specific number, which is part of the routing information, used by the networks to route the call and the non-call related signalling message.

NOTE: The Routing Number conveys information for use by the network. If the digits dialled by the user matches the digits of a Routing Number, the dialled digits shall not be interpreted as a Routing Number.

3.3 Networks

3.3.1 carrier network

The network selected by the carrier selection procedure for routing a call.

3.3.2 donor network

The network from which a number is ported.

3.3.3 initial donor network

The initial network to which a number range was allocated by the NPA.

3.3.4 originating network

The network where the calling party is located.

NOTE 1: For incoming calls to the routing domain, the originating network is effectively the first network receiving the call within the routing domain. For example, for incoming international calls, the originating network is effectively the network containing the international switching centre (ISC). In a PLMN, the equivalent function is contained in the Gateway Mobile-services Switching Centre (GMSC).

NOTE 2: For carrier selection, the network containing the first exchange of the selected carrier becomes effectively the originating network for routing purposes as regards mobile number portability.

3.3.5 recipient network

The network where a number is located after being ported.

3.3.6 serving network

The network that determines whether a number has been ported, and, if so, provides an appropriate routing number.

3.3.7 terminating network

The network where the called party is located at the moment.

3.3.8 transit network

A network switching calls and conveying non-call related signalling messages between two other networks.

3.4 Exchanges

3.4.1 gateway exchange (GW)

An exchange with Point(s) of Interconnection to exchanges in other national or international networks.

NOTE: The latter may be called International Switching Centre (ISC), or Gateway Mobile-services Switching Centre (GMSC) in a PLMN.

3.4.2 originating exchange

The first exchange in the Originating Network.

3.4.3 serving exchange

The exchange performing the check of whether a Directory Number is ported.

3.5 Other definitions

3.5.1 administrative database (AdmDB)

The Service Provider's database, not call-related or with any similar function, in charge of the storage and updating of the Operational Database of ported Directory Numbers necessary for the Service Provider's correct routing of calls and non-call related signalling messages.

3.5.2 administrative interface

The interface between Service Providers' Administrative Databases, and between the Service Providers' Administrative Databases and the Reference Database, if implemented.

NOTE: See Figure 3:1.

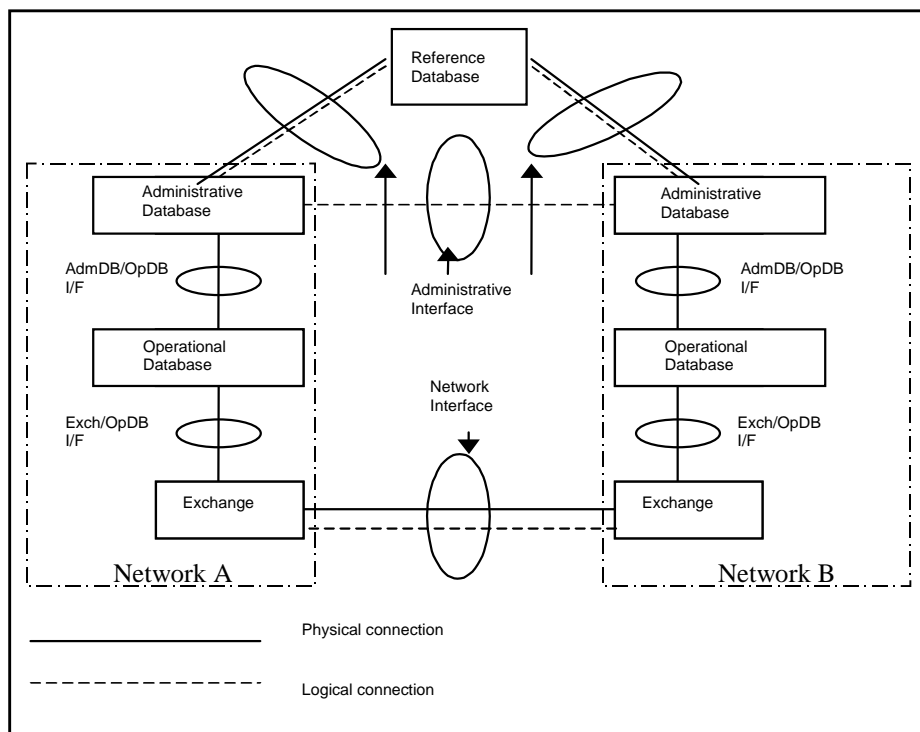

Figure 3:1

3.5.3 initial address message

The message sent to set up a speech path through the network.

3.5.4 interrogating network entity

The entity that submits a non-call related signalling message to interrogate the HLR.

3.5.5 mobile number portability

Service provider portability for public digital mobile telephony services within a country.

3.5.6 national numbering plan

A national numbering plan provides a structure for the numbers used and the number space available in a country.

NOTE: See ref. [12] for the structure of the Swedish numbering plan for telephony.

3.5.7 non-call related signalling message

All signalling messages where the Directory Number is used to route the message on SCCP level except MAP SRI without the Optimal Routing parameter being set.

3.5.8 network interface

The interface between public telecommunications operators which supports Mobile Number Portability.

NOTE: See Figure 3:1.

3.5.9 operational database (OpDB)

A database used in real-time by the network operator or service provider for the correct routing of calls and non-call related signalling messages to ported Directory Numbers.

NOTE: The Operational Database could form part of an IN implementation, could be embedded within the exchange or could be some other type of on-line database, e.g. HLR. The size of the Operational Database could depend on routing method.

3.5.10 operator identity

Identity of a Public Telecommunications Operator.

3.5.11 point of interconnection (POI)

A connection point between public telecommunications networks.

3.5.12 portability check

The function whereby a network, e.g. the serving network, performs a check of whether a Directory Number is ported.

3.5.13 portability domain

The part of the number ranges of the national numbering plan where number portability is supported for a certain type of public telecommunications service.

NOTE: One Portability Domain may represent e.g. specified fixed subscriber number ranges, another number ranges for public digital mobile telephony services.

3.5.14 reference database (RefDB)

The database in charge of the storage and updating of the Administrative Databases of the Service Providers' ported Directory Numbers.

NOTE: The data stored is used for correct routing of calls and non-call related signalling messages by all PTOs in the Routing Domain using the All Call Query (call related) and Direct Routing (non-call related) methods. The Reference Database can be centralised (CRefDB) or distributed (DRefDB).

3.5.15 release message

The message sent to release a speech path in the network.

3.5.16 routing domain

The part of the national public telecommunications network obliged to perform a portability check and to route the call and non-call related signalling message accordingly.

NOTE: The Routing Domain includes the Portability Domain.

3.5.17 service provider portability

A function enabling the subscribers to cancel their subscriptions with a Service Provider and to contract another subscription with another Service Provider, without changing their Directory Numbers and the nature of the service offered.

4 Abbreviations

ACQ	All Call Query method
AdmDB	Administrative Database
CC	Country Code
CCBS	Completion of Calls to Busy Subscriber
CdPA	Called Party Address
CdPN	Called Party Number
CRefDB	Centralised Reference Database
DN	Directory Number
DRefDB	Distributed Reference Database
ETSI	European Telecommunications Standards Institute
GMSC	Gateway Mobile-services Switching Centre
GSM	Global System for Mobile communications
GW	Gateway Exchange
HLR	Home Location Register
IAM	Initial Address Message
IN	Intelligent Network
ITS	Information Technology Standardisation.
ISC	International Switching Centre
ISDN	Integrated Services Digital Network
ISUP	ISDN User Part
MAP	Mobile Application Part
MNP	Mobile Number Portability
MNP-SRF	Signalling Relay Function for support of MNP
MSISDN	Mobile Station International ISDN Number
NAI	Nature of Address Indicator (SCCP)
NDC	National Destination Code
N(S)N	National (Significant) Number
NoA	Nature of Address indicator (ISUP)
NPA	Numbering Plan Administration
NPTA	National Post & Telecom Agency, the national regulatory authority for the telecommunications sector
OpDB	Operational Database
OR	Onward Routing method
PLMN	Public Land Mobile Network
POI	Point of Interconnection
PTO	Public Telecommunications Operator
RefDB	Reference Database
REL	Release Message
SCCP	Signalling Connection Control Part
SMS	Short Message Service
SN	Subscriber Number
SRI	Send Routing Information
UDT	Unitdata
VLR	Visitor Location Register
VMSC	Visited MSC
XUDT	Extended Unitdata

5 Methods and Procedures of Mobile Number Portability

5.1 General

The methods of realising mobile number portability in Sweden in connection with a change of Service Provider are All Call Query and Onward Routing for call related traffic and Direct Routing and Indirect Routing for non-call related traffic.

The methods are all based on the ETSI standards for MNP [2]. The terms All Call Query (ACQ) and Onward Routing (OR) have been chosen in order to correspond

with the terms used for call related traffic for service provider portability for fixed public telecommunications services, in SS 63 63 90:1999 Edition 1 [7]. The corresponding terms for All Call Query (call related), used in the ETSI standards for MNP, are Originating call Query on Digit Analysis (OQoD) and Direct Routing. The corresponding terms for Onward Routing (call related), used in the ETSI standards for MNP, are Terminating call Query on Digit Analysis (TQoD), Query on HLR Release (QoHR) and Indirect Routing. However, since the terms ACQ and OR are by definition call related, the terms Direct Routing and Indirect Routing are used for non-call related traffic, as in the ETSI MNP standards [2].

All Call Query (call related) and Direct Routing (non-call related), as defined in this standard, are the preferred technical methods of realising mobile number portability, as it offers the most efficient routing of calls and non-call related signalling messages to the recipient network.

Onward Routing (call related) and Indirect Routing (non-call related), as defined in this standard, are intended for Service Providers without an Operational and/or Administrative Database for all ported numbers in the Portability Domain. The Onward Routing and Indirect Routing methods lead to less efficient routing of calls compared with the All Call Query and Direct Routing methods.

The choice of implementing the chosen call related methods All Call Query and Onward Routing by using either an IN-based or MNP-SRF solution, as described in the ETSI standards for MNP [2], is regarded as operator dependent. This does however not apply for the MNP-SRF solution used by the Indirect Routing with Reference to Recipient Network method, which is not fulfilling the Network Integrity precondition and shall therefore not be used for MNP in Sweden.

For the chosen non-call related methods Direct Routing and Indirect Routing, only one solution is specified in the ETSI standards for MNP [2], i.e. the MNP-SRF solution.

The originating network, when using the All Call Query (call related) and Direct Routing (non-call related) methods, may use any optional information supplied over the Administrative Interface to handle e.g. routing, accounting and charging of calls and non-call related signalling messages to ported numbers in accordance with its own rules or rules agreed to by the recipient network, see Section 10.2.

To ensure correct identification for e.g. public emergency services, calls from ported Directory Numbers shall be treated as ordinary calls as regards Calling Line Identification Presentation.

In Sweden, two-step routing is applied to call related and non-call related traffic. This means that the routing information given to a call to a ported number only points out the recipient network. To be able to terminate the call, the recipient network may need to add routing information.

All traffic handling cases and the specific mobile number portability signalling information are explained in Annex A.

5.2 Call related methods

5.2.1 All Call Query method

All Call Query is the preferred and long-term technical method supporting the mobile number portability Network Interface.

If the originating network in the Routing Domain supports the All Call Query method, it is obliged **to route calls to all ported Directory Numbers in the Portability Domain** towards the Recipient Network. The number shall be indicated as a ported number.

Before a call is routed to another network, a portability check of the called Directory Number shall be performed, in order to clarify whether the called Directory Number is or is not ported out from any network within the Portability Domain.

- If the check indicates that the called Directory Number is ported, the call is routed towards the recipient network on the basis of information once received over the Administrative Interface. At the Point of Interconnection, a call to a ported number is identified as described in Clause 9. Charging and accounting is performed on the basis of information once received over the Administrative Interface.
- If the check indicates that the called Directory Number is not ported, ordinary routing procedures will be followed.

5.2.2 Onward Routing method

Onward Routing is the alternative method of supporting the mobile number portability Network Interface. This method requires bilateral agreements between the public telecommunications operators.

If the originating network in the Routing Domain supports the Onward Routing method, it is obliged **to route calls to ported Directory Numbers from its own number ranges** towards the Recipient Network. The number shall be indicated as a ported number.

If the Directory Number does not belong to the originating network's own number ranges, the call is routed to the network of the Number Range Holder, according to ordinary routing procedures.

If the Directory Number belongs to the originating network's own number ranges, a portability check of the called Directory Number must be performed in order to clarify whether the called Directory Number is ported out from the network's own number ranges.

- If the check indicates that the called Directory Number is ported to another network, the call is routed towards that other network on the basis of the information once received over the Administrative Interface¹. At the Point of Interconnection, a call to a ported number is identified as described in Clause 9. Charging and accounting is performed on the basis of information once received over the Administrative Interface.
- If the check indicates that the called Directory Number is not ported, ordinary routing procedures will be followed.

5.3 Non-call related methods

Non-call related functions are needed to support teleservices, e.g. SMS as defined in ITU-T Rec. I.210, see reference [5], and supplementary services, e.g. CCBS.

5.3.1 Direct Routing method

Direct Routing is the preferred and long-term technical method supporting the mobile number portability Network Interface.

If the originating network in the Routing Domain supports the Direct Routing method, it is obliged **to route non-call related signalling messages to all ported Directory Numbers in the Portability Domain** towards the Recipient Network. The number shall be indicated as a ported number.

Before a non-call related signalling message is routed to another network, a portability check of the Directory Number, used to route the non-call related signalling message, shall be performed, in order to clarify whether the Directory Number is or is not ported out from any network within the Portability Domain.

¹ The Administrative Interface for the Onward Routing method is the interface over which relevant routing information has been received. This interface may be the AdmDB/OpDB I/F or the Exch/OpDB I/F as shown in Figure 3.1.

- If the check indicates that the Directory Number, used to route the non-call related signalling message, is ported, the non-call related signalling message is routed towards the recipient network on the basis of information once received over the Administrative Interface. At the Point of Interconnection, a non-call related signalling message to a ported number is identified as described in Clause 9. Charging and accounting can be performed on the basis of information once received over the Administrative Interface.
- If the check indicates that the Directory Number, used to route the non-call related signalling message, is not ported and belonging to another network, it will be indicated that a portability check has been performed and ordinary routing procedures will be followed. At the Point of Interconnection, a non-call related signalling message to a checked and not ported number is identified as described in Clause 9.

5.3.2 Indirect Routing method

Indirect Routing is the alternative method of supporting the mobile number portability Network Interface. This method requires bilateral agreements between the public telecommunications operators.

If the originating network in the Routing Domain supports the Indirect Routing method, it is obliged **to route non-call related signalling messages to ported Directory Numbers from its own number ranges** towards the Recipient Network. The number shall be indicated as a ported number.

If the Directory Number does not belong to the originating network's own number ranges, the non-call related signalling message is routed to the network of the Number Range Holder, according to ordinary routing procedures.

If the Directory Number belongs to the originating network's own number ranges, a portability check of the Directory Number, used to route the non-call related signalling message, must be performed in order to clarify whether the Directory Number, used to route the non-call related signalling message, is ported out from the network's own number ranges.

- If the check indicates that the Directory Number, used to route the non-call related signalling message, is ported to another network, the non-call related signalling message is routed towards that other network on the basis of the information once received over the Administrative Interface². At the Point of Interconnection, a non-call related signalling message to a ported number is identified as described in Clause 9. Charging and accounting can be performed on the basis of information once received over the Administrative Interface.
- If the check indicates that the Directory Number, used to route the non-call related signalling message, is not ported, ordinary routing procedures will be followed.

5.4 Agreements and information on implemented methods and interworking

In order to achieve effective routing through the networks, all Public Telecommunications Operators within the Routing Domain shall inform all other directly interconnected Public Telecommunications Operators about which method they support.

5.4.1 Call related methods

The Onward Routing method requires bilateral agreements between the Public Telecommunications Operators concerned.

² The Administrative Interface for the Indirect Routing method is the interface over which relevant routing information has been received. This interface may be the AdmDB/OpDB I/F or the Exch/OpDB I/F as shown in Figure 3.1.

A network acting as an All Call Query network receiving a call from an Onward Routing network shall perform a portability check of calls to all numbers within the Portability Domain, except for calls already marked as calls to ported numbers.

A network receiving a call from a network acting as an All Call Query network within the Routing Domain need not perform any portability check.

An Onward Routing network receiving a call from an Onward Routing network shall perform a portability check of all numbers where the second Onward Routing network is the number range holder.

5.4.2 Non-call related methods

The Indirect Routing method requires bilateral agreements between the Public Telecommunications Operators concerned.

A network acting as a Direct Routing network receiving a non-call related signalling message from an Indirect Routing network shall perform a portability check of non-call related signalling messages to all numbers within the Portability Domain, except for non-call related signalling messages already marked as messages to ported numbers.

A network receiving a non-call related signalling message from a network acting as a Direct Routing network within the Routing Domain need not perform any portability check.

An Indirect Routing network receiving a non-call related signalling message from an Indirect Routing network shall perform a portability check of all numbers where the second Indirect Routing network is the number range holder.

6 Traffic handling cases

6.1 Normal procedures

6.1.1 Call related traffic

6.1.1.1 Calls coming into the Routing Domain

The first network within the Routing Domain receiving incoming calls from outside the Routing Domain is, in terms of mobile number portability, considered as the originating network.

An example is incoming international calls.

6.1.1.2 Requirements on calling line identification for public emergency services

The Calling Party Number shall remain unchanged for calls to ported Directory Numbers.

The Calling Party Number for calls from ported subscribers shall be the ported Directory Number.

6.1.1.3 Calls from ported numbers

Calls from ported Directory Numbers are treated as ordinary calls. Correct accounting of calls from ported numbers passing through a transit network is outside the scope of this standard.

6.1.1.4 Carrier selection

When a subscriber dials a carrier selection code for routing to a Carrier Network, or when carrier selection is invoked by preselection, the selected carrier is responsible for handling the call also with respect to mobile number portability.

In terms of mobile number portability, the selected Carrier Network shall be considered as the originating network. Carrier selection has priority over mobile number portability in the routing context.

NOTE: At present this applies to calls originating in an access network operator's fixed network and terminating in a PLMN, see Figure A7 in Annex A.

6.1.2 Non-call related traffic

6.1.2.1 Non-call related signalling messages coming into the Routing Domain

The first network within the Routing Domain receiving incoming non-call related signalling messages from outside the Routing Domain is, in terms of mobile number portability, considered as the originating network.

An example is incoming international non-call related signalling messages.

6.1.2.2 Non-call related signalling messages from ported numbers

Non-call related signalling messages from ported Directory Numbers are treated as ordinary non-call related signalling messages. Correct accounting of non-call related signalling messages from ported numbers passing through a transit network is outside the scope of this standard.

6.2 Abnormal cases

With abnormal procedures, the general principle is to release the connection as soon as possible to minimise the risk of looping or other network problems.

The following cases are identified for call related and non-call related traffic:

6.2.1 Call related traffic

6.2.1.1 Case 1

A recipient network within the Portability Domain receives a call with the indication of ported number. The recipient network does not recognise the called Directory Number as belonging to the network, or identifies the Directory Number as unallocated. Then the recipient network shall release the call with the Cause value #112, (Ported Number not found)³.

When the Cause Value #112 is received in the originating network, the call shall be released and appropriate action taken, e.g. an alarm referring to the specific cause value should be traced.

6.2.1.2 Case 2

A network within the Portability Domain receives a call without the indication of ported number from an originating or serving All Call Query network and has the possibility to determine that the call was received from an originating or serving All Call Query network. The network receiving the call does not recognise the called Directory Number as belonging to the network (i.e. being ported), or identifies the Directory Number as unallocated. Then the network receiving the call shall release the call with the Cause Value #112, (Ported Number not found) or Cause Value #1, (Unallocated Number).

The Cause value #112 can be used if the network receiving the call has the possibility of checking and verifying that the Directory Number is allocated to another network.

The Cause Value #1 shall be used if the Directory Number is not allocated to the network receiving the call and the network does not have the possibility of checking whether the Directory Number is allocated to another network, or if the result of the check is that the number is unallocated.

When the Cause Value #1 is received in the originating network, the call shall be released and appropriate action taken.

³ See Section 9.1.4.

When the Cause Value #112 is received in the originating network, the call shall be released and appropriate action taken, e.g. an alarm referring to the specific cause value should be traced.

6.2.1.3 Other cases

If an attempt is made to incorrectly route a call to a ported Directory Number towards a network outside the Portability Domain instead of towards the recipient network, the network receiving the call (in this case not the recipient network) is incapable of sending mobile number portability specific Cause Codes. In such a case, normal release codes are returned and appropriate action is taken.

If a call coming in from outside the Routing Domain results in release, the following shall apply. If the Cause Code generated is #1, it is transferred transparently to the originating network. If the Cause Code generated is #112, the first incoming network in the Routing Domain shall convert Cause Code #112 into Cause Code #1.

6.2.2 Non-call related traffic

To guard against the risk of routing information for a Directory Number being inconsistent between networks in a routing domain, the SCCP hop counter shall be used to prevent indefinite looping of messages between networks. The MNP-SRF shall then decrement the SCCP hop counter for every message relayed.

When the counter reaches the limit value zero, the message shall be returned to the originator of the message with the return code "hop counter violation". An alarm shall be issued and appropriate procedures initiated to remove the loop.

It should be noted that the use of the SCCP hop counter requires the use of unsegmented SCCP Extended Unitdata (XUDT) messages as defined in ITU-T Rec. Q.711 – Q.715 (07/96) [6].

7 Supplementary Services

As a general rule, the supplementary services supported in the donor network are not portable to the recipient network as regards Service Provider Portability. This does not exclude the same type of supplementary services from being supported in the Recipient Network and also being provided at interconnection with the Donor Network.

7.1 Call Forwarding Services

If a call is forwarded to a ported number, the network performing the redirection is, from a portability aspect, the originating network.

7.2 Presentation Services

The Calling Party Number shall be unchanged for calls to ported Directory Numbers.

The Calling Party Number of calls from ported subscribers shall be the ported Directory Number.

The Connected Party Number of calls to ported subscribers shall be the ported Directory Number.

7.3 Services using Transaction Capabilities

7.3.1 Short Message Service (SMS)

The Short Message Service shall not be affected, whether or not the Directory Number is ported, see Section 5.3.

NOTE: SMS is by definition a teleservice, see Section 5.3, but is described here in order to group services using Transaction Capabilities. These services are also dependent on the non-call related methods used for mobile number portability.

7.3.2 Completion of Calls to Busy Subscriber (CCBS)

The CCBS service shall not be affected whether or not the Directory Number is ported, see Section 5.3.

8 Cancellation of subscriptions

8.1 Call related traffic

If a subscription with a ported number is cancelled, there are two possible cases⁴.

1. The ported number shall remain with the Recipient Operator.
2. The ported number shall be returned.

If the subscription of a ported number is cancelled, the recipient network shall generate the appropriate tone or voice announcements during the vacancy period. When the vacancy period is over, the network currently holding the specific number shall take appropriate action in order to activate the relevant tone or voice announcements for calls to the Directory Number.

NOTE: If the network currently holding the specific number is changed, the Reference database shall be updated. This applies if there is a RefDB available.

8.2 Non-call related traffic

No specific procedures apply.

9 The Network Interface

9.1 Network interface for call related traffic

The Network Interface for call related traffic is based on SS 63 63 93:2000 Edition 1, PSTN-ISDN-PLMN ISUP signalling interface for Sweden [9], with the following clarifications.

9.1.1 General

Two information elements are transferred: first an indication that a Directory Number is ported, and secondly, routing information on the ported number.

The indication that the number is ported can be transferred either in terms of a Nature of Address indicator, which is the preferred method, or as leading digits prior to the Routing Number, the latter being an available method with the present structure of area codes in the Swedish numbering plan for telephony.

The routing information is conveyed as part of the Address Signal of the Called Party Number according to ITU-T Rec. Q.769.1, Annex A [3].

9.1.2 Called Party Number

Information about a ported number is provided to another network by the ISDN User Part (ISUP), Initial Address Message (IAM) in the Called Party Number parameter.

This parameter is coded in the following way:

Preferred method

Nature of Address Indicator

000 1000 value 8

(Network) Routing Number concatenated with Called Directory Number (for national use)

⁴ Depending on regulations published by NPTA under Swedish law.

Numbering Plan Indicator

01 The international public telecommunication numbering plan (ITU-T Rec. E.164 [24])

Address signal

ZXY+N(S)N	Routing Information
ZXY	Routing Number
N(S)N	National (Significant) Number

Alternative method

Nature of Address Indicator

000 0011 value 3 National (Significant) Number

Numbering Plan Indicator

01 The international public telecommunication numbering plan (ITU-T Rec. E.164 [24])

Address signal

ABC+ZXY+N(S)N	Routing Information
ABC	Ported Prefix (set to 394)
ZXY	Routing Number
N(S)N	National (Significant) Number

Structure of Routing Number

000	Reserved
001 – 499	For identification of the public telecommunications operator recipient network. Allocated by an independent entity.
500 – 599	Reserved for the Reference Database
600 – 799	Spare, allocated by an independent entity
8	Portability check performed, number not ported
9	For network internal use (The number of digits used is decided by each public telecommunications operator)

9.1.3 Calling Party Number, Original Called Number and Redirecting number

The ISDN User Part parameters Calling Party Number, Original Called Number, Redirecting Number and corresponding generic numbers are handled according to the Report ITS 9 Application Guide, ref. [11], as regards each supplementary service and with respect to interconnect agreements in force.

9.1.4 Cause Indicators

The coding of the Cause Indicator to be used in relation to mobile number portability is described below.

The Cause Indicator parameter is coded according to ITU-T Rec. Q.850, ref. [4]; the affected sub-fields of this Cause Value are coded in the following way.

Coding standard

1 0 National Standard

Cause value

Class	Value	No.	Definition
111	0000	112	Ported Number not found

This cause indicates that the call is cleared because the ported number is not allocated to the network indicated by the Called Party Number parameter. This may be due to e.g. a mismatch between the Called Party Number parameter information and the information in the Operational Database and/or the Administrative Database of the recipient network.

9.2 Network interface for non-call related traffic

The network interface for non-call related traffic is based on ITU-T Rec. Q.711 – Q.715 (07/96), Specifications of Signalling System No.7 – Signalling Connection Control Part (SCCP) [6] with the following clarifications and modifications.

9.2.1 General

The following clarifications and modifications are introduced for the support of Service Provider Portability in the network interface between two Public Telecommunications Operators. Two information elements are transferred: first, an indication that a portability check has been performed for the Directory Number, and secondly, routing information.

The indication that the number is ported is transferred in terms of a combination of a new value of the Nature of Address Indicator and information in the Routing Number. The Routing Number is a part of the routing information.

The routing information is conveyed as part of the Global title address information of the Called Party Address.

9.2.2 Called Party Address

Information about a ported number is provided to another network by the Signalling Connection Control Part (SCCP), Antidote message (UDT), in the Global title of the Called Party Address. The UDT message can carry different Mobile Application Part (MAP) messages in this context, depending on the service (e.g. Short Message Service (SMS) or Completion of Calls to Busy Subscriber (CCBS)).

The Global title is coded in the following way:

Directory Number portability check performed and ported

Global title when Global title indicator = 0100

Translation type

Coding depending on the application e.g. 0 for SMS and 17 for CCBS

Numbering plan indicator

0001 The international public telecommunication numbering plan (ITU-T Rec. E.164 [24])

Nature of Address Indicator

000 1000 value 8 (Network) Routing Number concatenated with Called Directory Number (for national use)

Address information

ZXY+CC+N(S)N	Routing Information
ZXY	Routing Number
CC+N(S)N	International number

Directory Number belonging to another network, portability check performed and not ported (Direct Routing method)

Global title when Global title indicator = 0100

Translation type

Coding depending on the application e.g. 0 for SMS and 17 for CCBS

Numbering plan indicator

0001

The international public telecommunication numbering plan (ITU-T Rec. E.164 [24])

Nature of Address Indicator

000 1000 value 8

(Network) Routing Number concatenated with Called Directory Number (for national use)

Address information

8+CC+N(S)N

8

Routing Information

Routing Number, portability check performed, number not ported. Normal routing on succeeding digits apply.

CC+N(S)N

International Number

Structure of Routing Number

See Section 9.1.2.

10 Information from the Administrative Interface

In this standard, the Administrative Interface is seen as an interface between the Public Telecommunications Operators' Administrative Databases and the Reference Database where information needed to handle mobile number portability is exchanged. The information once received over the Administrative Interface is interpreted and used in each operator's network according to the routing and charging rules of this network and agreements between the recipient and originating or donor networks.

The following mandatory information is identified for the technical solutions. The operators concerned must supply the mandatory information. The optional information, as described in SS 63 63 91 [8], may be supplied by agreement between the operators.

10.1 Mandatory information

Directory Number

The ported Directory Number.

Date and time of porting

The Year, Month, Day, Hour, Minute and Second of switchover. (See ref. [10], ISO 8601: 1991.)

Donor network/Operator identity

The identity of the public telecommunications operator's network, from which the Directory Number is ported. For a public telecommunications operator with more than one logical network, there shall be one identity for each network (e.g. one for PSTN/ISDN, and one for PLMN (GSM)).

Recipient network/Operator identity

The identity of the public telecommunications operator's network, to which the Directory Number is ported. For a public telecommunications operator with more than one logical network, there shall be one identity for each network (e.g. one for PSTN/ISDN, and one for PLMN (GSM)).

Annex A
 (informative)

Traffic handling cases

A.1 General

This annex provides information to help the reader understand the rules and procedures of mobile number portability solutions for public telecommunications networks in Sweden. The annex presents different examples of traffic handling cases illustrating the rules stated in Clauses 5 and 6.

The traffic handling cases are limited to the information exchanged over the Network Interface. Information used internally in a network is shown only for reasons of understanding. The Operational Database in originating Onward Routing (call related) and Indirect Routing (non-call related) networks is normally not illustrated in the figures.

Traffic to ported numbers can be set up through Transit Networks. Transit Networks that do not perform any portability checks are not shown in the figures. Only Transit Networks acting as Serving Networks are shown in the figures (only in Figure A3).

The Originating Network can be either a fixed public telecommunications network or a public land mobile network.

A.2 Normal procedures

A.2.1 Call related traffic

A.2.1.1 Originating network uses All Call Query

The Directory Number of the B subscriber is ported from a Donor Network to a Recipient Network within the Portability Domain. Subscriber A in an All Call Query network in the Routing Domain calls subscriber B. See Figure A1.

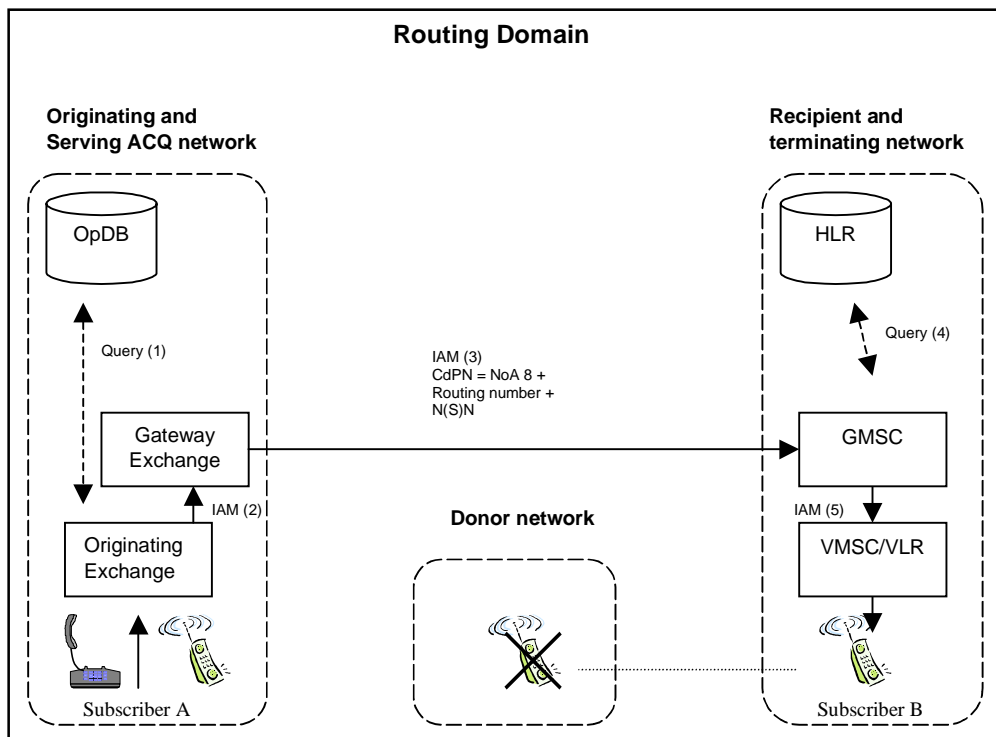

Figure A1

Routing:

Before the call is routed to another network, a portability check of the Directory Number is performed in the originating network. The number is marked as ported in the operational database. Information once received over the Administrative Interface is used for routing the call from the Originating Network towards the Recipient Network. The call is routed towards the Recipient Network using the Routing Number in the Address Signals of the Called Party Number.

When the call is presented at the Point of Interconnection to the Recipient Network, the Called Party Number parameter indicates the Directory Number as ported by NoA=8.

In the Recipient Network, a routing analysis of the received Directory Number is performed. This provides new information used for routing the call to the VMSC/VLR where Subscriber B is located at the moment.

Charging and Accounting:

Charging of the calling subscriber is performed in the Originating Network on the basis of information once received over the Administrative Interface. Accounting of the call is performed at each network interface according to agreed accounting procedures.

A.2.1.2 Originating network uses Onward Routing and Serving Initial Donor Network uses All Call Query

The Directory Number of the B subscriber is ported from the Serving All Call Query network to a Recipient Network but not to the originating Onward Routing network. Subscriber A in the Onward Routing network calls Subscriber B. See Figure A2.

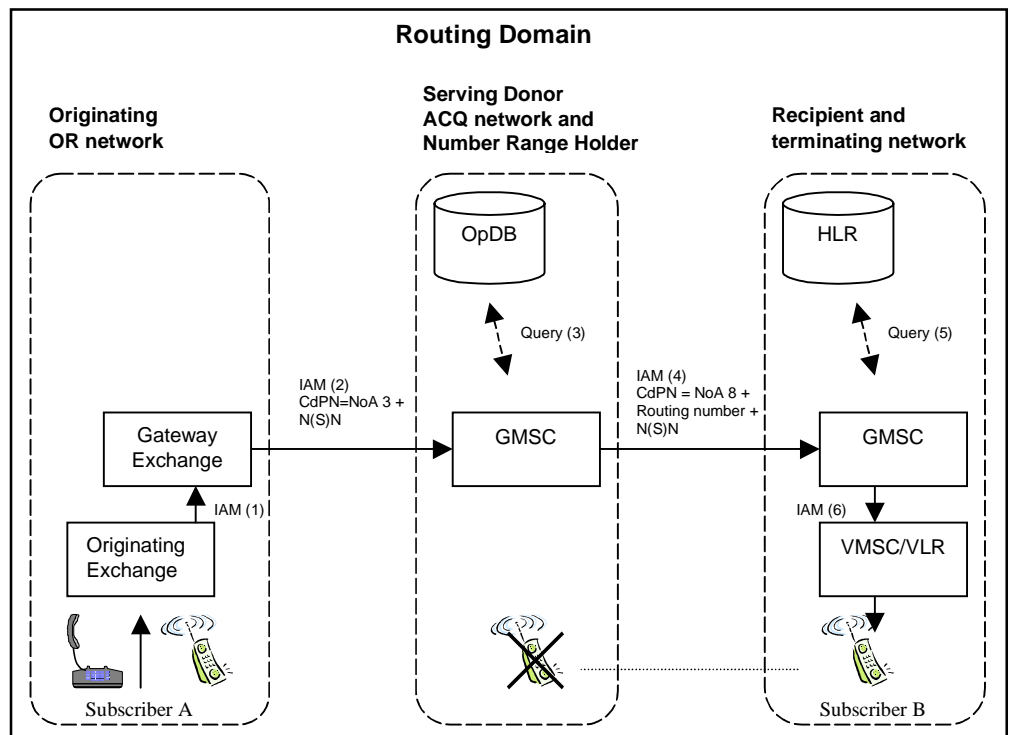

Figure A2

Routing:

The called Directory Number does not belong to the number ranges of the Originating Network. Thus the call is routed from the originating Onward Routing network towards the network, which is the Number Range Holder, without any

portability check of whether the number is ported. In the All Call Query network, a portability check of the Directory Number is performed and the result is that the number is marked as ported in the Operational Database. Information once received over the Administrative Interface is used for routing the call from the donor All Call Query network towards the Recipient Network. The call is routed towards the Recipient Network using the Routing Number in the Address Signals in the Called Party Number.

When the call is presented at the Point of Interconnection to the Recipient network, the Called Party Number parameter identifies the Directory Number as ported by NoA=8.

In the Recipient Network, a routing analysis of the received Directory Number is performed. This provides information used for routing the call to the VMSC/VLR where Subscriber B is located at the moment.

Charging and Accounting:

Charging of the calling subscriber is performed in the Originating Network on the basis of information once received over the Administrative Interface⁵. Accounting of the call is performed at each network interface according to agreed accounting procedures.

A.2.1.3 Originating network uses Onward Routing and Serving Transit Network uses All Call Query

The Directory Number of the B subscriber is ported from the Donor network to a Recipient Network, but not to the originating Onward Routing network. The Originating Network uses the All Call Query functionality of the Transit Network. Subscriber A in the Onward Routing network calls Subscriber B. See Figure A3.

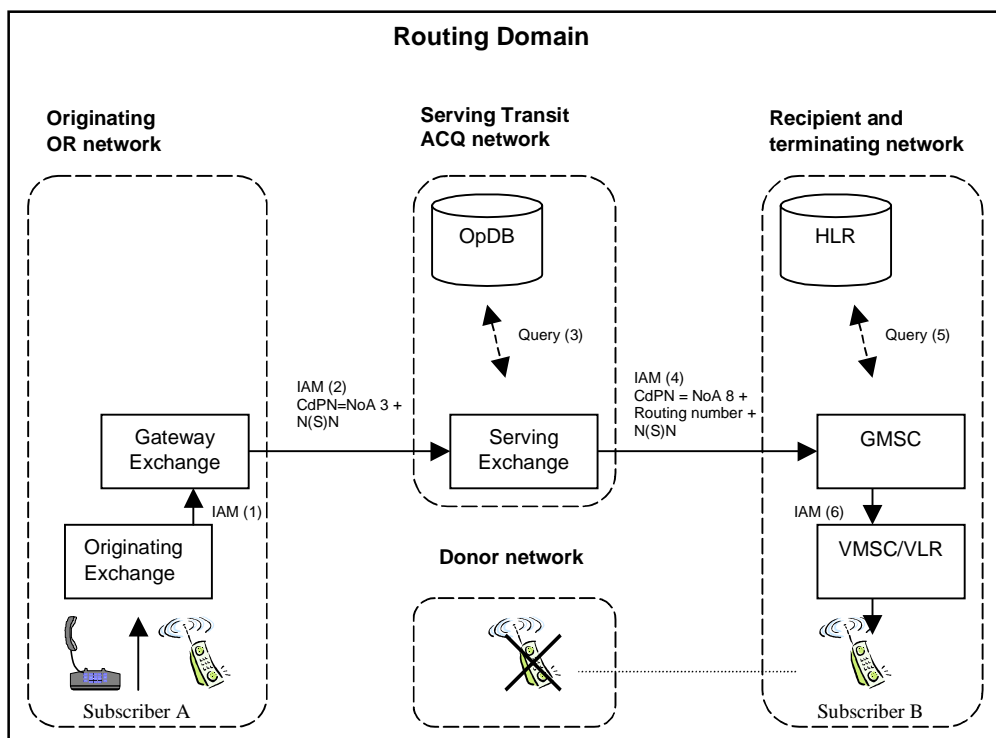

Figure A3

⁵ The Administrative Interface for the Onward Routing method is the interface over which relevant routing information has been received. This interface may be the AdmDB/OpDB I/F or the Exch/OpDB I/F as shown in Figure 3:1.

Routing:

The called Directory Number does not belong to the number ranges of the Originating Network. Thus the call is routed from the originating Onward Routing network towards the Serving Transit ACQ network, without any portability check of whether the number is ported. In the All Call Query network, a portability check of the Directory Number is performed and the result is that the number is marked as ported in the Operational Database. Information once received over the Administrative Interface is used for routing the call from the Transit All Call Query network towards the Recipient Network. The call is routed towards the Recipient Network using the Routing Number in the Address Signals in the Called Party Number.

When the call is presented at the Point of Interconnection to the Recipient network, the Called Party Number parameter identifies the Directory Number as ported by NoA=8.

In the Recipient Network, a routing analysis of the received Directory Number is performed. This provides information used for routing the call to the VMSC/VLR where Subscriber B is located at the moment.

Charging and Accounting:

Charging of the calling subscriber is performed in the Originating Network on the basis of information once received over the Administrative Interface⁶. Accounting of the call is performed at each network interface according to agreed accounting procedures.

A.2.1.4 Originating and Serving networks use Onward Routing

The Directory Number of the B subscriber is ported from an Initial Donor Onward Routing network to a Recipient Network, but not to the originating Onward Routing network. Subscriber A in the originating Onward Routing network calls Subscriber B. See Figure A4.

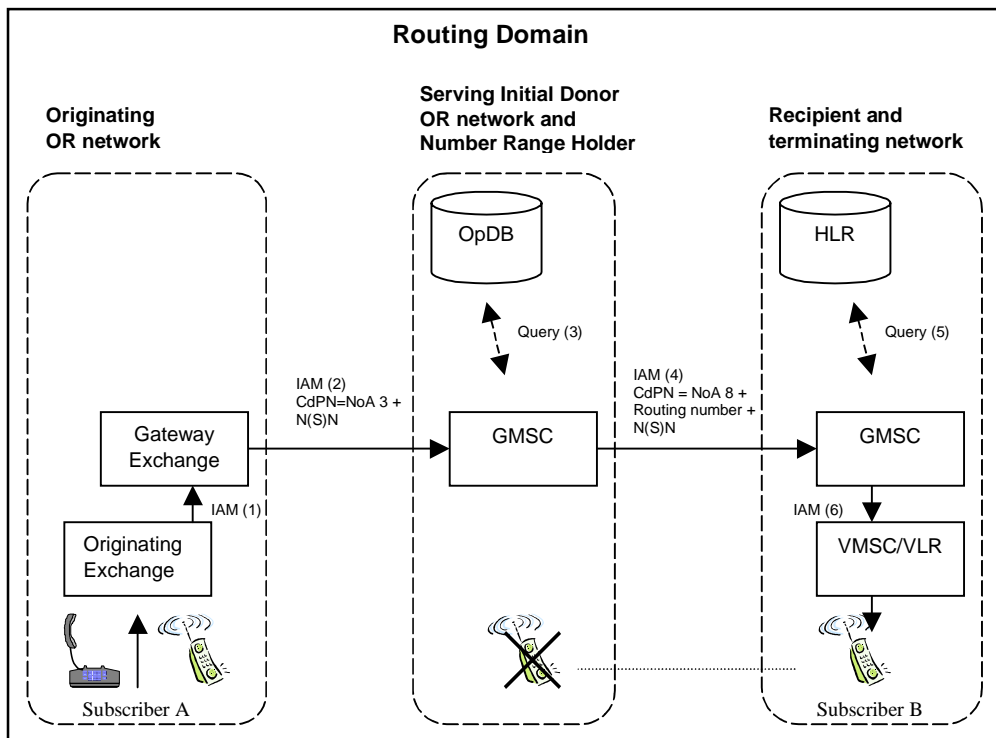

Figure A4

⁶ The Administrative Interface for the Onward Routing method is the interface over which relevant routing information has been received. This interface may be the AdmDB/OpDB I/F or the Exch/OpDB I/F as shown in Figure 3:1.

Routing:

Since the number range of the Called Directory Number is not allocated to the originating Onward Routing network, no portability check is performed. Thus the call is routed towards the network which is the Number Range Holder. In this network, which is an Onward Routing network, a portability check of the Directory Number is performed. The number is marked as ported in the Operational Database. Information once received over the Administrative Interface is used for routing the call from the second Onward Routing network towards the Recipient Network. The call is routed towards the Recipient Network using the Routing Number in the Address Signals in the Called Party Number.

When the call is presented at the Point of Interconnection to the Recipient Network, the Called Party Number parameter identifies the Directory Number as ported by NoA=8.

In the Recipient Network, a routing analysis of the received Directory Number is performed. This provides new information used for routing the call to the VMSC/VLR where Subscriber B is located at the moment.

Charging and Accounting:

Charging of the calling subscriber is performed in the Originating Network on the basis of information once received over the Administrative Interface⁷. Accounting of the call is performed at each network interface according to the agreed accounting procedures.

A.2.1.5 The called party number is ported from a number range belonging to the originating Onward Routing network

The Directory Number of the B subscriber is ported from the originating Onward Routing network. Subscriber A in this network calls Subscriber B. See Figure A5.

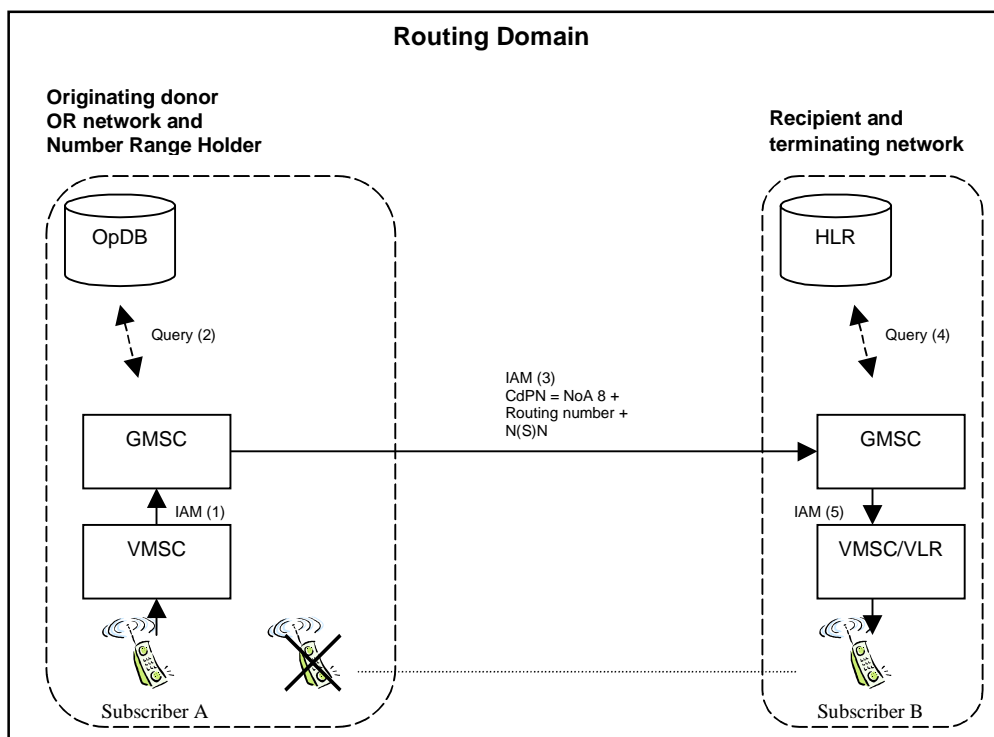

Figure A5

⁷ The Administrative Interface for the Onward Routing method is the interface over which relevant routing information has been received. This interface may be the AdmDB/OpDB I/F or the Exch/OpDB I/F as shown in Figure 3:1.

Routing:

Before the call is routed, a portability check of the Directory Number is performed in the Originating Network as Number Range Holder. The result of the portability check is that the number is marked as ported in the Operational Database. Information once received over the Administrative Interface is used for routing the call from the Originating Network towards the Recipient Network. The call is routed towards the Recipient Network using the Routing Number in the Address Signals in the Called Party Number.

When the call is presented at the Point of Interconnection to the Recipient Network, the Called Party Number parameter identifies the Directory Number as ported by NoA=8.

In the Recipient Network, a routing analysis of the received Directory Number is performed. This provides information used for routing the call to the VMSC/VLR where Subscriber B is located at the moment.

Charging and Accounting:

Charging of the calling subscriber is performed in the Originating Network on the basis of information once received over the Administrative Interface⁸. Accounting of the call is performed at each network interface according to the agreed accounting procedures.

A.2.1.6 Incoming call from outside the Routing Domain

The Directory Number of the B subscriber is ported from a network in the Portability Domain. A call comes in from outside the Routing Domain. See Figure A6.

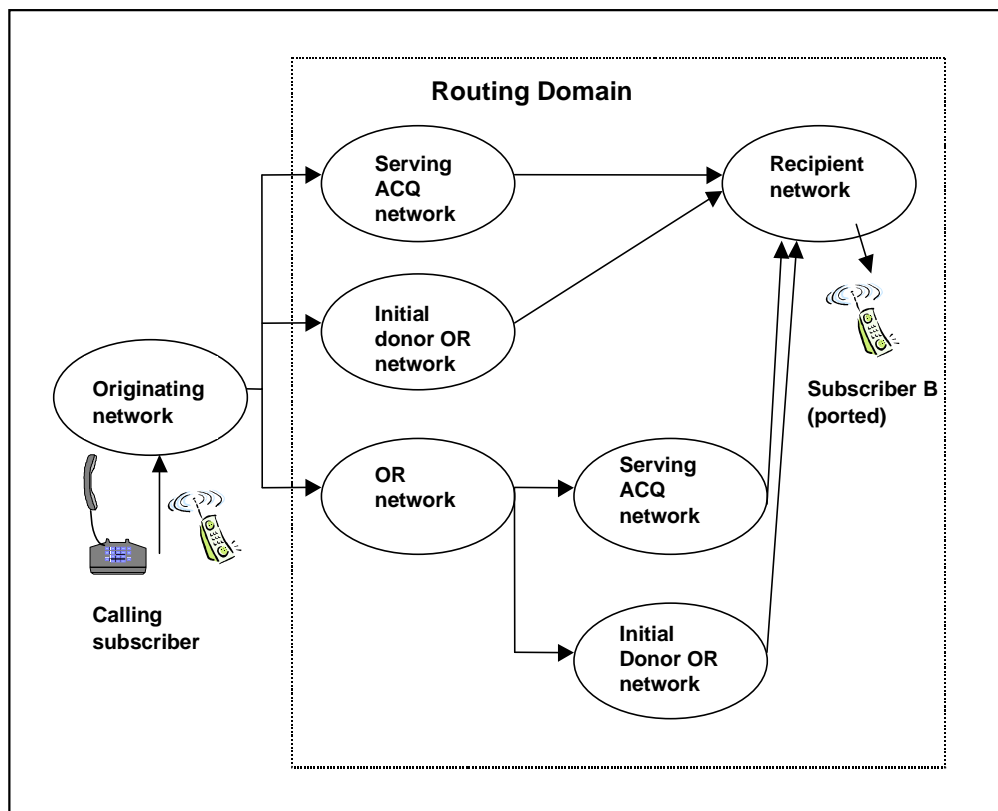

Figure A6

⁸ The Administrative Interface for the Onward Routing method is the interface over which relevant routing information has been received. This interface may be the AdmDB/OpDB I/F or the Exch/OpDB I/F as shown in Figure 3:1.

Routing:

When the call enters the first network in the Routing Domain, the following alternatives are possible.

If the first network is of the All Call Query type, this network effectively becomes originating, and applicable procedures are those described in Section A.2.1.1.

If the first network is of the Onward Routing type, this network effectively becomes originating, and applicable procedures are those described in Sections A.2.1.2, A.2.1.3, A.2.1.4 or A.2.1.5.

Charging and Accounting:

Charging is performed by the Network Operator of the calling subscriber. Accounting of the call is performed at each network interface according to agreed accounting procedures.

A.2.1.7 Calling Subscriber using Carrier Selection

The Directory Number of the B subscriber is ported from one network to another within the Portability Domain. Subscriber A in an Originating Access Network Operator, not the Carrier Network, calls subscriber B using carrier selection (call-by-call selection or pre-selection). See Figure A7.

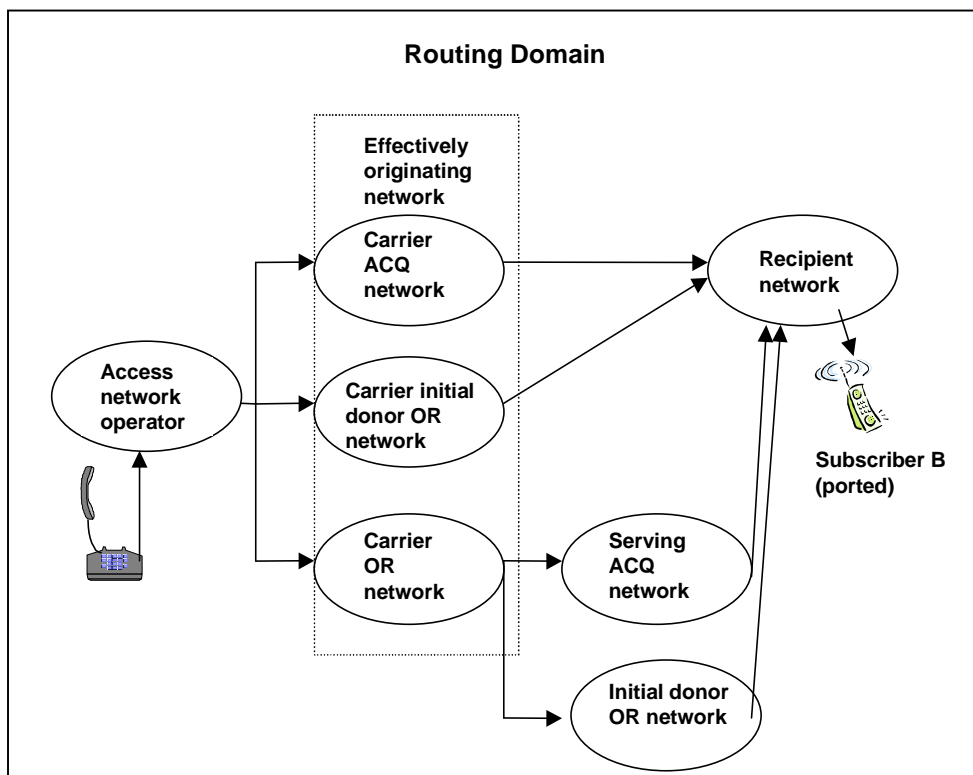

Figure A7

Routing:

The originating network routes the call towards the Carrier Network. The call is presented at the Point of Interconnection as an ordinary call, but with carrier selection information, see Report ITS 9 [12]. Subscriber B is ported and either of the following procedures applies, depending on which mobile number portability method is implemented.

1. If the Carrier Network supports All Call Query, applicable procedures are those described in Section A.2.1.1.
2. If the Carrier Network supports Onward Routing, applicable procedures are those described in Sections A.2.1.2, A.2.1.3, A.2.1.4 or A.2.1.5.

Charging and accounting:

Charging is performed in the Carrier Network. Accounting of the call is performed at each network interface according to agreed procedures.

A.2.2 Non-call related traffic

The traffic handling cases are limited to four basic cases and are intended to explain the main routing principles of the Direct and Indirect Routing methods. More specific traffic handling cases relevant to e.g. SMS are explained in ETSI EN 301 716 [2]. Only information specific to mobile number portability exchanged over the Network interface is shown in the figures.

A.2.2.1 Originating network uses Direct Routing

The Directory Number of the B subscriber is ported from a Donor Network to a Recipient Network within the Portability Domain. Subscriber A in a Direct Routing network in the Routing Domain using a service that initiates a non-call related signalling message, uses the Directory Number of Subscriber B as address. See Figure A8.

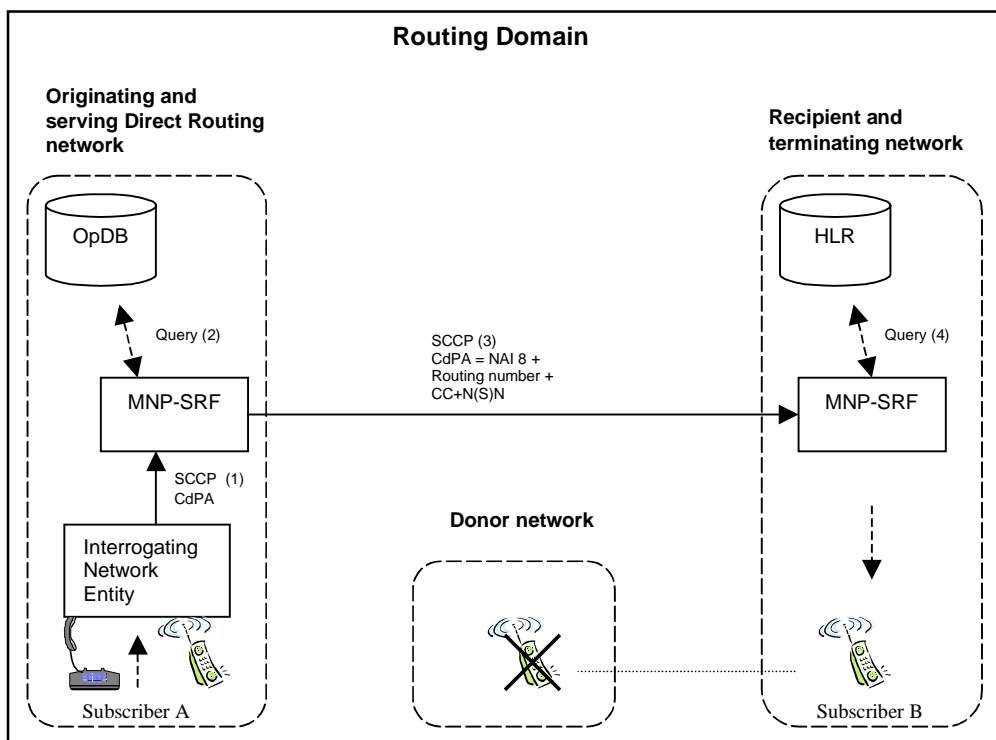

Figure A8

Routing:

Before the non-call related signalling message is routed to another network, a portability check of the Directory Number is performed in the Originating Network. The number is marked as ported in the operational database. Information once received over the Administrative Interface is used for routing the non-call related signalling message from the Originating Network towards the Recipient Network. The non-call related signalling message is routed towards the Recipient Network using the Routing Number in the Address information of the SCCP Called Party Address.

When the non-call related signalling message is presented at the Point of Interconnection to the Recipient Network, the SCCP Called Party Address parameter indicates the Directory Number as portability checked and ported.

In the Recipient Network, a routing analysis of the received Directory Number is performed. This provides new information used for routing the non-call related signalling message to the B subscriber.

Charging and Accounting:

Charging of the subscriber who sends the non-call related signalling message can be performed in the Originating Network on the basis of information once received over the Administrative Interface. Accounting of non-call related traffic is performed at each network interface according to agreed accounting procedures.

A.2.2.2 Originating network uses Indirect Routing

The Directory Number of the B subscriber is ported from an Initial Donor Indirect Routing network to a Recipient Network, but not to the originating Indirect Routing network. Subscriber A in the originating Indirect Routing network using a service that initiates a non-call related signalling message, uses the Directory Number of Subscriber B as address. See Figure A9.

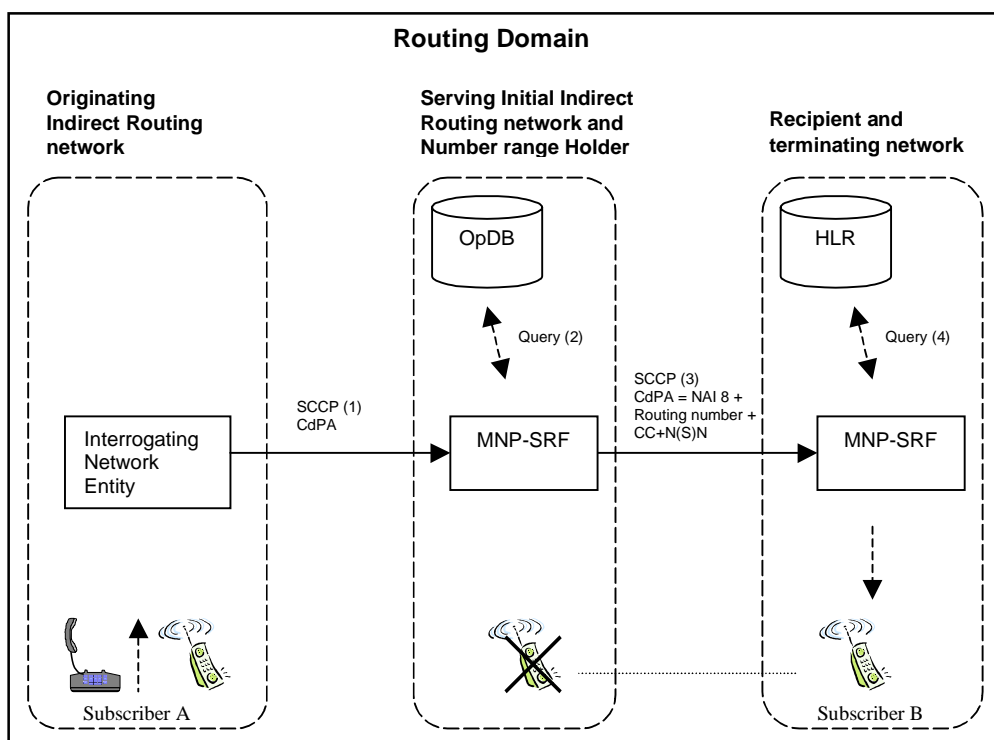

Figure A9

Routing:

Since the number range of the Called Directory Number is not allocated to the originating Indirect Routing network, no portability check is performed. Thus the non-call related signalling message is routed towards the network which is the Number Range Holder. In this network, which is an Indirect Routing network, a portability check of the Directory Number is performed. The number is marked as ported in the Operational Database. Information once received over the Administrative Interface is used for routing the non-call related signalling message from the second Indirect Routing network towards the Recipient Network. The non-call related signalling message is routed towards the Recipient Network using the Routing Number in the Address information in the SCCP Called Party Address.

When the non-call related signalling message is presented at the Point of Interconnection to the Recipient Network, the SCCP Called Party Address parameter identifies the Directory Number as portability checked and ported.

In the Recipient Network, a routing analysis of the received Directory Number is performed. This provides new information used for routing the non-call related signalling message to the B Subscriber.

Charging and Accounting:

Charging of the subscriber for a non-call related signalling message can be performed in the Originating Network on the basis of information once received over the Administrative Interface⁹. Accounting of non-call related traffic is performed at each network interface according to agreed accounting procedures.

A.2.2.3 The called party number is ported from a number range belonging to the Originating Network

The Directory Number of the B subscriber is ported from the Originating Network. Subscriber A in this network using a service that initiates a non-call related signalling message, uses the Directory Number of Subscriber B as address. See Figure A10.

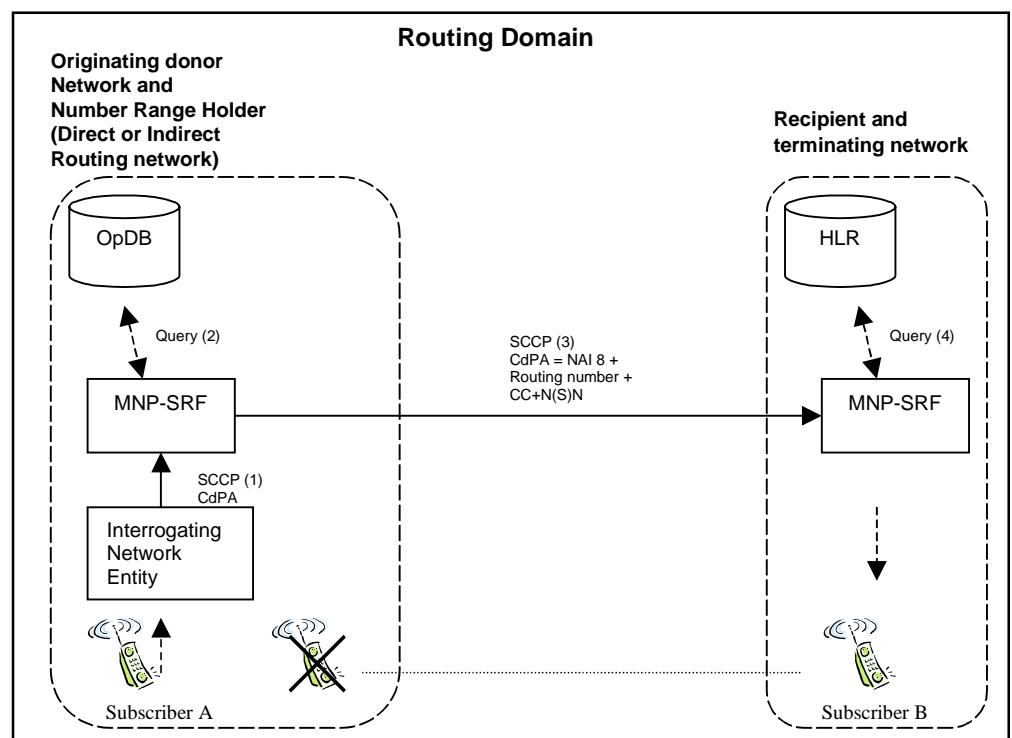

Figure A10

Routing:

Before the non-call related signalling message is routed, a portability check of the Directory Number is performed in the Originating Network as Number Range Holder. The result of the portability check is that the number is marked as ported in the Operational Database. Information once received over the Administrative Interface is used for routing the non-call related signalling message from the Originating Network towards the Recipient Network. The non-call related signalling message is routed towards the Recipient Network using the Routing Number in the Address information in the SCCP Called Party Address.

When the non-call related signalling message is presented at the Point of Interconnection to the Recipient Network, the SCCP Called Party Address parameter identifies the Directory Number as portability checked and ported.

⁹ The Administrative Interface for the Indirect Routing method is the interface over which relevant routing information has been received. This interface may be the AdmDB/OpDB I/F or the Exch/OpDB I/F as shown in Figure 3:1.

In the Recipient Network, a routing analysis of the received Directory Number is performed. This provides information used for routing the non-call related signalling message to the B Subscriber.

Charging and Accounting:

Charging of the subscriber for a non-call related signalling message can be performed in the Originating Network on the basis of information once received over the Administrative Interface¹⁰. Accounting of non-call related traffic is performed at each network interface according to agreed accounting procedures.

A.2.2.4 Incoming non-call related signalling message from outside the Routing Domain

The Directory Number of the B subscriber is ported from a network in the Portability Domain. A non-call related signalling message comes in from outside the Routing Domain. See Figure A11.

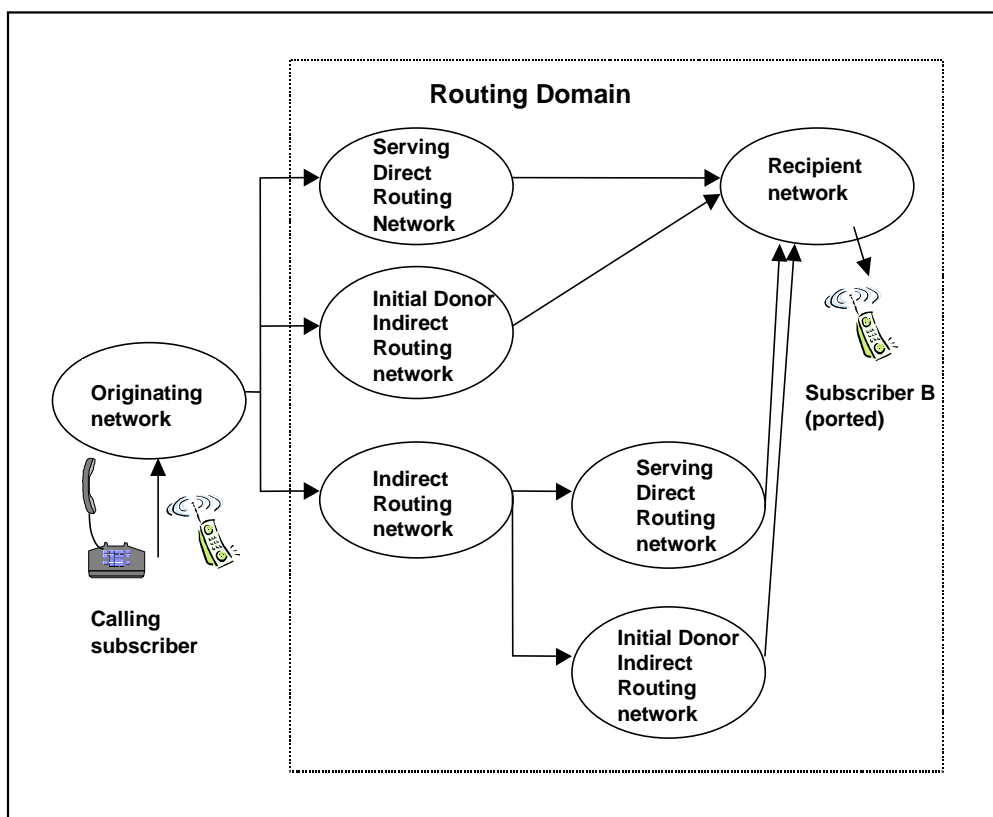

Figure A11

Routing:

When the non-call related signalling message enters the first network in the Routing Domain, the following alternatives are possible.

If the first network is of the Direct Routing type, this network effectively becomes originating, and applicable procedures are those described in Section A.2.2.1 or A.2.2.3.

If the first network is of the Indirect Routing type, this network effectively becomes originating, and applicable procedures are those described in Section A.2.2.2 or A.2.2.3.

¹⁰ The Administrative Interface for the Indirect Routing method is the interface over which relevant routing information has been received. This interface may be the AdmDB/OpDB I/F or the Exch/OpDB I/F as shown in Figure 3:1.

Charging and Accounting:

Charging is performed by the Network Operator of the subscriber using a service that initiates the non-call related signalling message. Accounting of non-call related traffic is performed at each network interface according to agreed accounting procedures.

A.3 Abnormal cases

A.3.1 Call related traffic

A.3.1.1 Case 1

The originating All Call Query or originating Initial Donor Onward Routing network routes a call to the Recipient Network **with** indication of a call to a ported number. The Called Directory Number is ported from the Recipient Network or unallocated. The information in the Operational Database of the Originating Network is in conflict with the information in the Operational Database of the Recipient Network. See Figure A12.

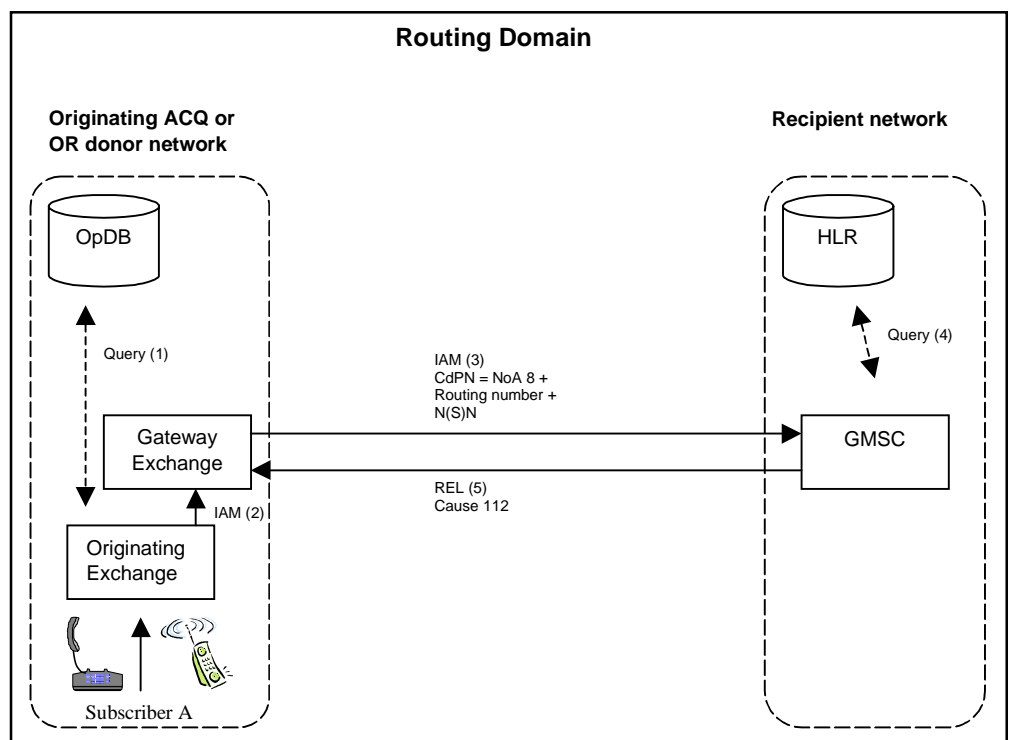

Figure A12

Routing:

As the Directory Number is indicated as ported, the call is routed according to the routing information fetched from the Operational Database of the Originating Network.

In the Recipient Network, a check of the received Directory Number is performed. The result of the check is that the number does not belong to the network or that it is unallocated. Therefore the network releases the call and returns a Release Message with the Cause Value #112, **Ported Number not found**.

A.3.1.2 Case 2

The originating All Call Query network routes a call to the Number Range Holder Network **without** indication of a call to a ported number. The Called Directory Number is ported from the Number Range Holder Network, but the information is not present in the Operational Database of the Originating Network. See Figure A13.

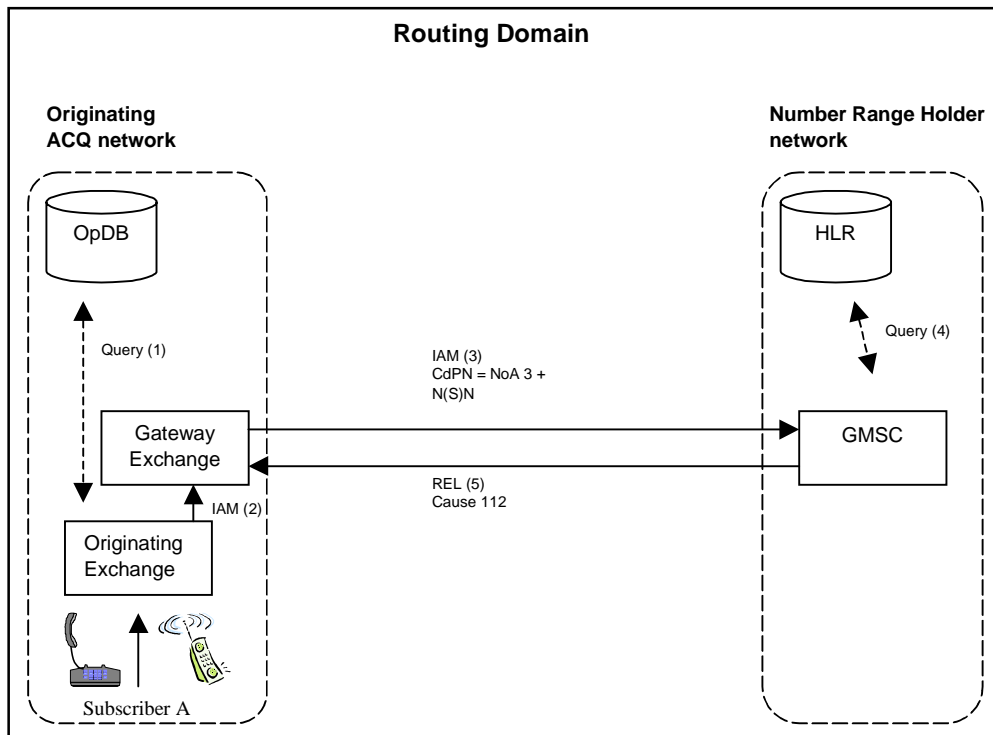

Figure A13

Routing:

Since the Directory Number is not marked as ported in the Originating Network, ordinary routing from the Originating to the Number Range Holder Network is performed. The Number Range Holder Network does not recognise the number, and as the network has the possibility of checking whether the number is ported, a check of the received Directory Number is performed. As the check verifies that the number has been ported to another network, the Number Range Holder Network releases the call and returns a Release message with the Cause Value #112, **Ported Number not found.**

A.3.2 Non-call related traffic

No specific procedures apply.